



Rental Grade Unit MMG125 - 108kW John Deere

Generator-Mounted
Voltage Selector Switch

Sound Attenuated, Rust-Free
Aluminum Enclosure

Single-Point Lifting

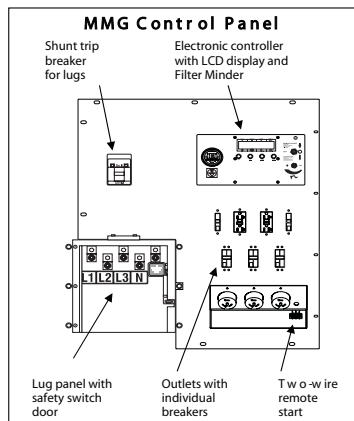

Easy Access to
Services Ports

Lockable
External Fuel Fill

24 Hour Fuel
Tank in Skid



TOUGH

- ALUMINUM ENCLOSURE
- LOCKABLE ENCLOSURE
- STEEL SKID AND TRAILER
- DURABLE POWDER COAT FINISH

RELIABLE

- SOPHISTICATED MICROPROCESSOR
- VOLTAGE REGULATION WITHIN 1%
- 24 HOUR FULL LOAD RUN TIME
- AIR FILTER CONDITION INDICATOR
- 1 YEAR 1,000 HOUR WARRANTY

EASY TO USE

- VOLTAGE SELECTOR SWITCH
- LUGS AND LUG BOX SAFETY SWITCH
- MULTIPLE CONVENIENCE OUTLETS
- EXTERNAL EMERGENCY STOP SWITCH
- EXTERNAL, LOCKABLE FUEL CAP
- AUTOMATIC REMOTE START
- ENHANCED MOTOR
- STARTING OPTION AVAILABLE

Rental Grade Unit

MMG125 - 108kW John Deere

Output	
3 Phase - Standby (kW/kVa)	108 / 135
Amps (480/208 V)	162 / 375
3 Phase - Prime (kW/kVa)	100 / 125
Amps (480/208 V)	150 / 347
1 Phase - Standby (kW/kVa)	97 / 97
Amps (240 V)	404
1 Phase - Prime (kW/kVa)	90 / 90
Amps	375
AC Voltage - 1 Phase	120, 139, 208, 220, 240, 277
AC Voltage - 3 Phase	208, 220, 440, 480
Frequency Hz.	60
Power Factor	1.0 (1 Phase) / .8 (3 Phase)
Generator (Brand/Type/Insulation)	Marathon / Brushless / H
Sound (dB(A) 23 Feet @ Prime)	68
Size & Weight	
Skid Mounted (L x Wx H)	132 x 50 x 73
Dry Weight lb. (kg.)	5260 (2390)
Operating Weight lb. (kg.)	7020 (3185)
Trailer Mounted (L x W x H) (in.)	210 x 86 x 90
Dry Weight lb. (kg.)	7200 (3270)
Operating Weight lb. (kg.)	8960 (4060)
Engine	
Brand	John Deere
Aspiration	Turbo
HP (Prime @ 1800 rpm) (kWm)	150 (112)
Displacement C.I.D. (l.)	415 (6.8)
Cylinders	6
Speed (rpm)	1800
Fuel Consumed (Prime gal. (l.)/h)	7.7 (29.1)
Battery (12 volt)	1 - 12V/1000 CCA
Capacities	
Fuel Tank gal.(l.)	245 (927)
Approximate Run Time (hrs.)	28
Coolant qt. (l.)	42 (39.7)
Oil qt. (l.)	18 (17)
AC Distribution	
Main Breaker	450
Voltage Selection	3 Position Switch (Locable)
Voltage Regulation	+/-1%
120V - 20 Amp GFI Duplex	2
240V - 30 Amp Twist Lock	NA
240V - 50 Amp Twist Lock	3
Trailer	
Number of Axles & Capacity (lbs.)	2 (6000)
Tire Size (in.)	16
Brakes	Surge / Electric
Hitch	2" Ball / 3" Ring